

Ref Doc: 1		No. 0399		Rev. 1	
Product:		Nutricare Button Compact Set		Application:	
				Enteral	
Technical Qualification					
Raw Materials:		Medical Grade Silicone, Polycarbonate			
Packing:		Blister tray – I Kit			
Regulatory:		CE marked according to directive 93/42/EEC - Class IIB			
Others:		Free from Latex DEHP, PVC, Bisphenol A, animal tissues, drugs, or products derived from human blood		Shelf life 3 years	
Products: Nutricare Button Compact Set includes – Gastrostomy button, pre-measured stiffener, balloon syringe 10ml, compress (x4), lubricant, 1 x 30cm Feed set, Y ENFit, right angled					
Code:		Description:			
GB10421208		Nutricare Button Compact Set, size: 12Fr, length: 08mm			
GB10421210		Nutricare Button Compact Set, size: 12Fr, length: 10mm			
GB10421212		Nutricare Button Compact Set, size: 12Fr, length: 12mm			
GB10421215		Nutricare Button Compact Set, size: 12Fr, length: 15mm			
GB10421217		Nutricare Button Compact Set, size: 12Fr, length: 17mm			
GB10421220		Nutricare Button Compact Set, size: 12Fr, length: 20mm			
GB10421223		Nutricare Button Compact Set, size: 12Fr, length: 23mm			
GB10421225		Nutricare Button Compact Set, size: 12Fr, length: 25mm			
GB10421227		Nutricare Button Compact Set, size: 12Fr, length: 27mm			
GB10421230		Nutricare Button Compact Set, size: 12Fr, length: 30mm			
GB10421235		Nutricare Button Compact Set, size: 12Fr, length: 35mm			
GB10421240		Nutricare Button Compact Set, size: 12Fr, length: 40mm			
GB10421245		Nutricare Button Compact Set, size: 12Fr, length: 45mm			
GB10421250		Nutricare Button Compact Set, size: 12Fr, length: 50mm			
GB10421408		Nutricare Button Compact Set, size: 14Fr, length: 08mm			
GB10421410		Nutricare Button Compact Set, size: 14Fr, length: 10mm			
GB10421412		Nutricare Button Compact Set, size: 14Fr, length: 12mm			
GB10421415		Nutricare Button Compact Set, size: 14Fr, length: 15mm			
GB10421417		Nutricare Button Compact Set, size: 14Fr, length: 17mm			
GB10421420		Nutricare Button Compact Set, size: 14Fr, length: 20mm			
GB10421423		Nutricare Button Compact Set, size: 14Fr, length: 23mm			
GB10421425		Nutricare Button Compact Set, size: 14Fr, length: 25mm			
GB10421427		Nutricare Button Compact Set, size: 14Fr, length: 27mm			
GB10421430		Nutricare Button Compact Set, size: 14Fr, length: 30mm			
GB10421435		Nutricare Button Compact Set, size: 14Fr, length: 35mm			

GB10421440	Nutricare Button Compact Set, size: 14Fr, length: 40mm
GB10421445	Nutricare Button Compact Set, size: 14Fr, length: 45mm
GB10421450	Nutricare Button Compact Set, size: 14Fr, length: 50mm
GB10421608	Nutricare Button Compact Set, size: 16Fr, length: 8mm
GB10421610	Nutricare Button Compact Set, size: 16Fr, length: 10mm
GB10421612	Nutricare Button Compact Set, size: 16Fr, length: 12mm
GB10421615	Nutricare Button Compact Set, size: 16Fr, length: 15mm
GB10421617	Nutricare Button Compact Set, size: 16Fr, length: 17mm
GB10421620	Nutricare Button Compact Set, size: 16Fr, length: 20mm
GB10421623	Nutricare Button Compact Set, size: 16Fr, length: 23mm
GB10421625	Nutricare Button Compact Set, size: 16Fr, length: 25mm
GB10421627	Nutricare Button Compact Set, size: 16Fr, length: 27mm
GB10421630	Nutricare Button Compact Set, size: 16Fr, length: 30mm
GB10421635	Nutricare Button Compact Set, size: 16Fr, length: 35mm
GB10421640	Nutricare Button Compact Set, size: 16Fr, length: 40mm
GB10421645	Nutricare Button Compact Set, size: 16Fr, length: 45mm
GB10421650	Nutricare Button Compact Set, size: 16Fr, length: 50mm
GB10421808	Nutricare Button Compact Set, size: 18Fr, length: 8mm
GB10421810	Nutricare Button Compact Set, size: 18Fr, length: 10mm
GB10421812	Nutricare Button Compact Set, size: 18Fr, length: 12mm
GB10421815	Nutricare Button Compact Set, size: 18Fr, length: 15mm
GB10421817	Nutricare Button Compact Set, size: 18Fr, length: 17mm
GB10421820	Nutricare Button Compact Set, size: 18Fr, length: 20mm
GB10421823	Nutricare Button Compact Set, size: 18Fr, length: 23mm
GB10421825	Nutricare Button Compact Set, size: 18Fr, length: 25mm
GB10421827	Nutricare Button Compact Set, size: 18Fr, length: 27mm
GB10421830	Nutricare Button Compact Set, size: 18Fr, length: 30mm
GB10421835	Nutricare Button Compact Set, size: 18Fr, length: 35mm
GB10421840	Nutricare Button Compact Set, size: 18Fr, length: 40mm
GB10421845	Nutricare Button Compact Set, size: 18Fr, length: 45mm
GB10421850	Nutricare Button Compact Set, size: 18Fr, length: 50mm
GB10422008	Nutricare Button Compact Set, size: 20Fr, length: 8mm
GB10422010	Nutricare Button Compact Set, size: 20Fr, length: 10mm
GB10422012	Nutricare Button Compact Set, size: 20Fr, length: 12mm
GB10422015	Nutricare Button Compact Set, size: 20Fr, length: 15mm
GB10422017	Nutricare Button Compact Set, size: 20Fr, length: 17mm
GB10422020	Nutricare Button Compact Set, size: 20Fr, length: 20mm
GB10422023	Nutricare Button Compact Set, size: 20Fr, length: 23mm
GB10422025	Nutricare Button Compact Set, size: 20Fr, length: 25mm
GB10422027	Nutricare Button Compact Set, size: 20Fr, length: 27mm
GB10422030	Nutricare Button Compact Set, size: 20Fr, length: 30mm
GB10422035	Nutricare Button Compact Set, size: 20Fr, length: 35mm

GB10422040	Nutricare Button Compact Set, size: 20Fr, length: 40mm
GB10422045	Nutricare Button Compact Set, size: 20Fr, length: 45mm
GB10422050	Nutricare Button Compact Set, size: 20Fr, length: 50mm
GB10422408	Nutricare Button Compact Set, size: 24Fr, length: 8mm
GB10422410	Nutricare Button Compact Set, size: 24Fr, length: 10mm
GB10422412	Nutricare Button Compact Set, size: 24Fr, length: 12mm
GB10422415	Nutricare Button Compact Set, size: 24Fr, length: 15mm
GB10422417	Nutricare Button Compact Set, size: 24Fr, length: 17mm
GB10422420	Nutricare Button Compact Set, size: 24Fr, length: 20mm
GB10422423	Nutricare Button Compact Set, size: 24Fr, length: 23mm
GB10422425	Nutricare Button Compact Set, size: 24Fr, length: 25mm
GB10422427	Nutricare Button Compact Set, size: 24Fr, length: 27mm
GB10422430	Nutricare Button Compact Set, size: 24Fr, length: 30mm
GB10422435	Nutricare Button Compact Set, size: 24Fr, length: 35mm
GB10422440	Nutricare Button Compact Set, size: 24Fr, length: 40mm
GB10422445	Nutricare Button Compact Set, size: 24Fr, length: 45mm
GB10422450	Nutricare Button Compact Set, size: 24Fr, length: 50mm

Intended Use:

The G-Button is a **replacement feeding tube** for long-term enteral administration of nutrients and medication directly into the stomach and may not be inserted into the existing and healed stoma for at least 6 weeks after a PEG is inserted. Furthermore, the G-Button is indicated for patients with a low risk of aspiration and/or require **gastric decompression**

Using Recommendations:

Available sizes from Fr 12 to 24 and lengths from 8mm to 50mm to best fit the patient's stoma size

- Balloon volume indicated on the inflation valve
- Radiopaque stripe along the shaft
- Recessed tip to avoid trauma
- Flat, rounded tip to avoid trauma
- High comfort due to flexible silicone

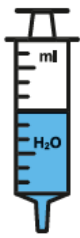
	<i>Fr/CH</i>	<i>ml</i>
	12	3.0
	14	4.0
	16	5.0
	18	5.0
	20	8.0
24	8.0	

Pictures:

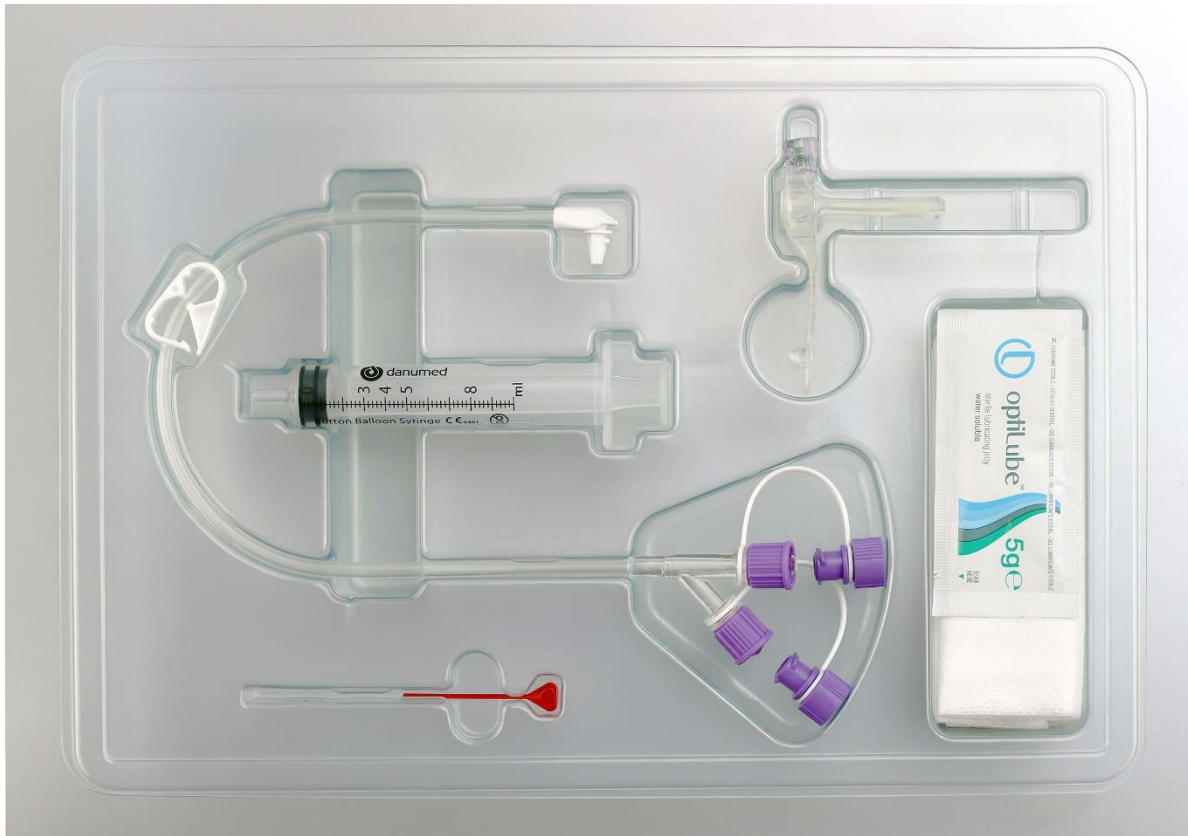

Packaging:

Packaging type	No. of units	H (mm)	W (mm)	D (mm)	G. Weight (KG)
Shelf Box	1	40	210	310	0.326
Shipper/Carton	5	280	210	320	1.84
Code:		Quantity per Pallet:		Pallet Dimensions:	
All		450		Euro	

Description:

Primary Artwork

Nutricare™ Button Compact Set

ENFit® 

Low Profile Gastrostomy Feeding Tube

-  Bouton De Gastrostomie
-  Botón De Gastrostomia
-  Bottone Per Gastrostomia
-  Gastrostomie-Button
-  Gastrostomi-Knapp (Button)
-  Gastrostomi-Button
-  Gastrostomiknapp

REF GB XXXX XXXX

LOT XXXXXX

SIZE: XX Fr

 XXXXXX





LENGTH: XX mm

 XXXXXX

Quantity: 1 unit

Distributed by:
GBUK Group Ltd.
Woodland House,
Blackwood Hall Business Park
North Duffield, Selby, North Yorkshire
YO8 5DD, UK
www.gbukgroup.com

danumed Medizintechnik GmbH
Stadthof 18
DE-93059 Regensburg
GERMANY www.danumed.com

Nutricare™ Button Compact Set		Nutricare™ Button Compact Set	
REF GB XXXX XXXX	LOT XXXXXX	REF GB XXXX XXXX	LOT XXXXXX
SIZE: XX Fr LENGTH: XX mm	 XXXXXX	SIZE: XX Fr LENGTH: XX mm	 XXXXXX
Nutricare™ Button Compact Set		Nutricare™ Button Compact Set	
REF GB XXXX XXXX	LOT XXXXXX	REF GB XXXX XXXX	LOT XXXXXX
SIZE: XX Fr LENGTH: XX mm	 XXXXXX	SIZE: XX Fr LENGTH: XX mm	 XXXXXX



Description:

Secondary Artwork

Nutricare™ Button Compact Set

ENFit® 

Low Profile Gastrostomy Feeding Tube

Quantity: 1 unit

-  Bouton De Gastrostomie
-  Botón De Gastrostomia
-  Bottone Per Gastrostomia
-  Gastrostomie-Button
-  Gastrostomi-Knapp (Button)
-  Gastrostomi-Button
-  Gastrostomiknapp

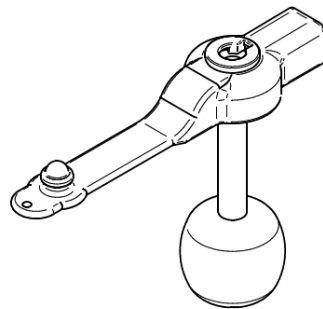

danumed Medizintechnik GmbH
Stadthof 18
DE-93059 Regensburg
GERMANY
www.danumed.com

Distributed by:
GBUK Group Ltd.
Woodland House,
Blackwood Hall Business Park
North Duffield, Selby, North Yorkshire
YO8 5DD, UK
www.gbukgroup.com



Nutricare™ Button Compact Set

REF GB XXXX XXXX

SIZE: XX Fr LENGTH: XX mm

LOT XXXXXX

XXXXXX

XXXXXX



(01) 042515184xxxx
(10)
(17)

Description:

Tertiary Artwork

Nutricare™ Button Compact Set

ENFit® ENSwivel

Low Profile Gastrostomy Feeding Tube

Quantity: 5 units

- Bouton De Gastrostomie
- Botón De Gastrostomia
- Bottone Per Gastrostomia
- Gastrostomie-Button
- Gastrostomi-Knapp (Button)
- Gastrostomi-Button
- Gastrostomiknapp

danumed Medizintechnik GmbH
Stadthof 18
DE-93059 Regensburg
GERMANY
www.danumed.com

Distributed by:
GBUK Group Ltd.
Woodland House,
Blackwood Hall Business Park
North Duffield, Selby, North Yorkshire
YO8 5DD, UK
www.gbukgroup.com



REF GBXXXXXXXX

SIZE: XX Fr LENGTH: XX mm

LOT XXXXXX

XXXXXX

XXXXXX



(01) 042515184xxxx
(10)
(17)



Latex-free PVC-free DEHP-free BPA-free

Modified by: Nicola Robertson

Date: 17.6.22

Reviewed by: Nicola Robertson

Date: 17.6.22



GBUK Enteral is a trading name of GBUK Enteral Ltd.
GBUK Enteral Ltd. Is part of GBUK Group Ltd.

GBUK Enteral
Woodland House
Blackwood Hall Business Park
North Duffield, North Yorkshire
YO8 5DD, UK

TEL: +44 (0) 1757 282 945
<https://www.gbukgroup.com/>
<https://www.gbukgroup.com/brands/gbuk-ental/>